

Stereochimica

2022 03 01

Proiezioni di Newman
di alcani e cicloalcani.

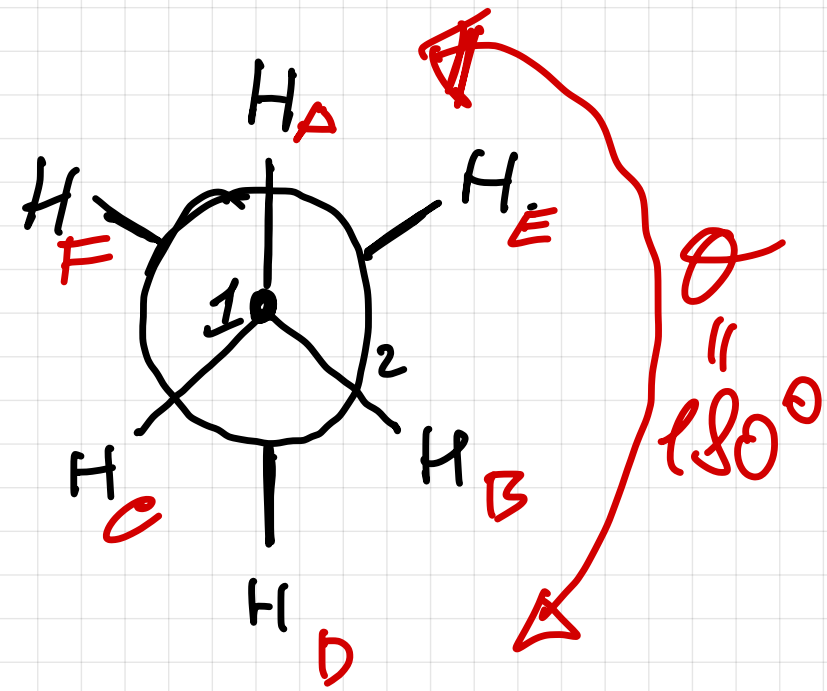
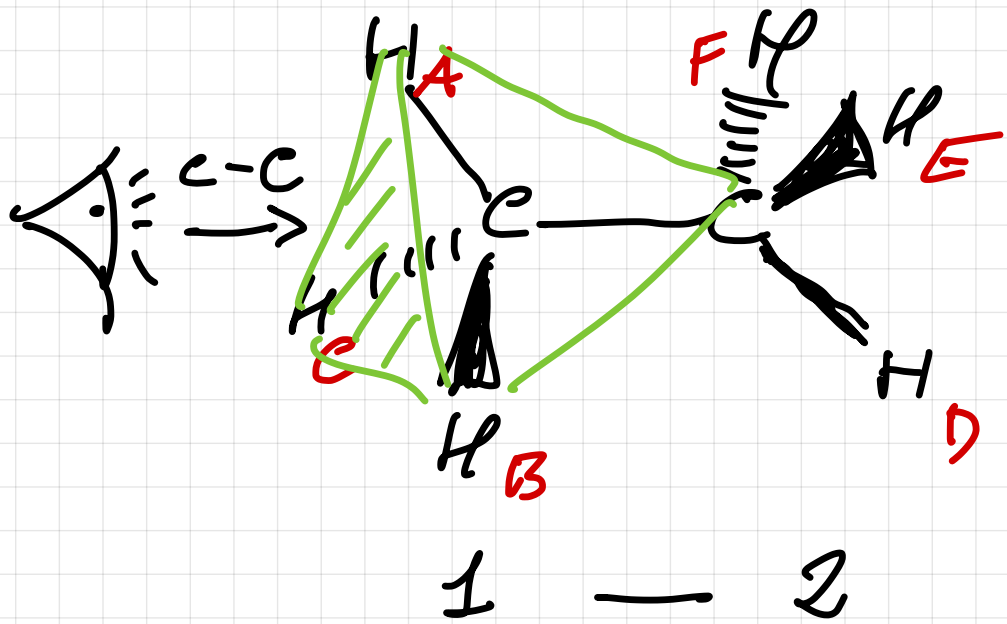

CONFORMAZIONE
SFALDATA

In ciascuno dei casi mostrati di seguito, disegna una proiezione di Newman vista dall'angolo indicato dall'osservatore.

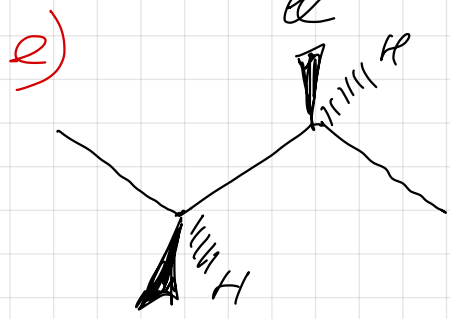
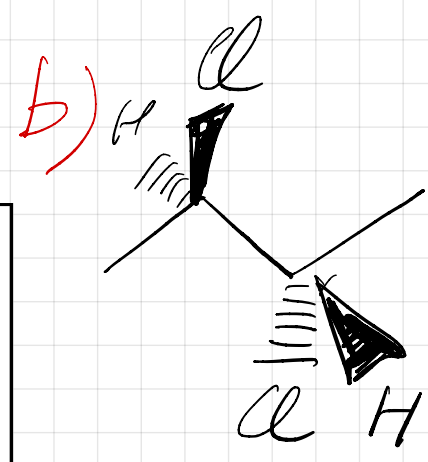
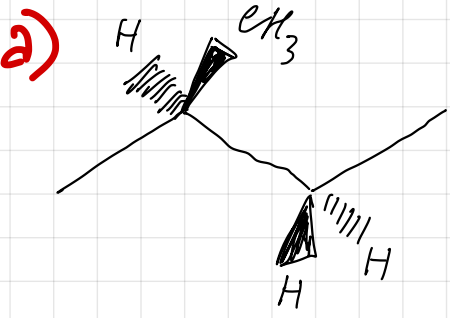

$C_2 \rightarrow C_3$

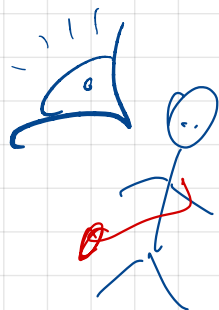
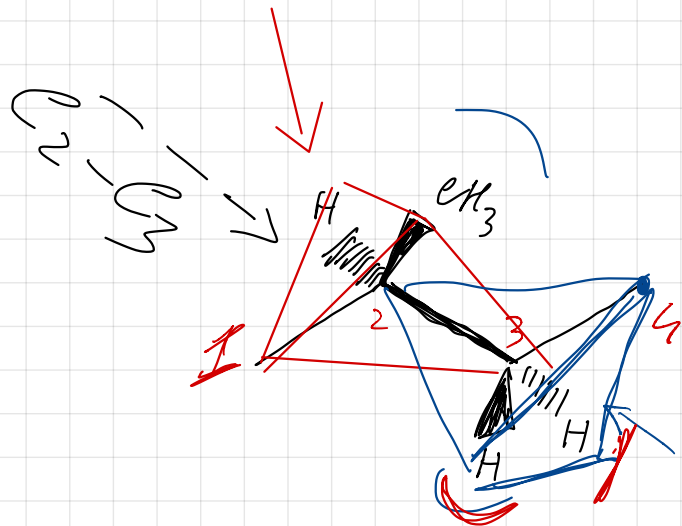

$C_3 - C_2$

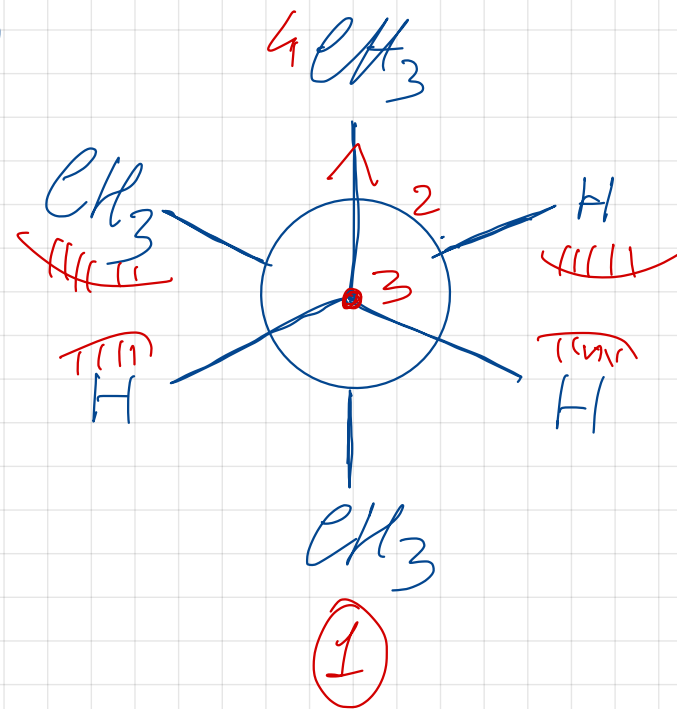
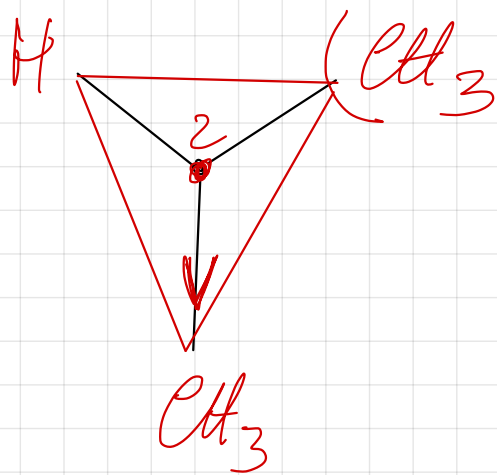
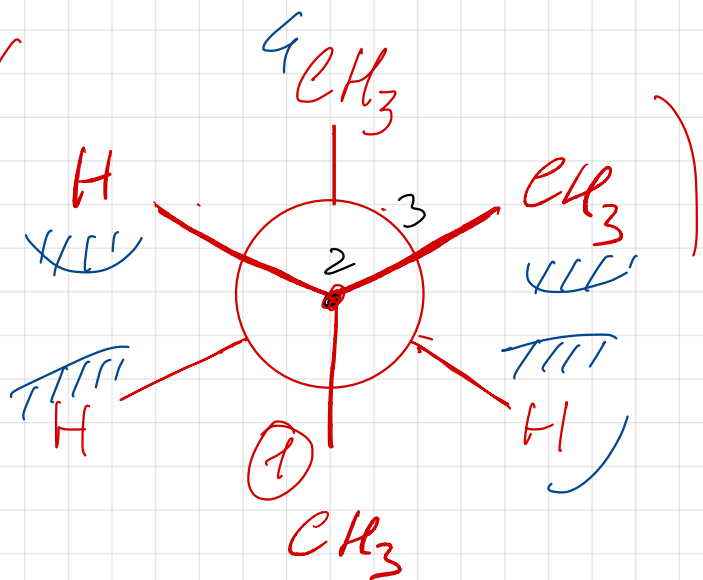

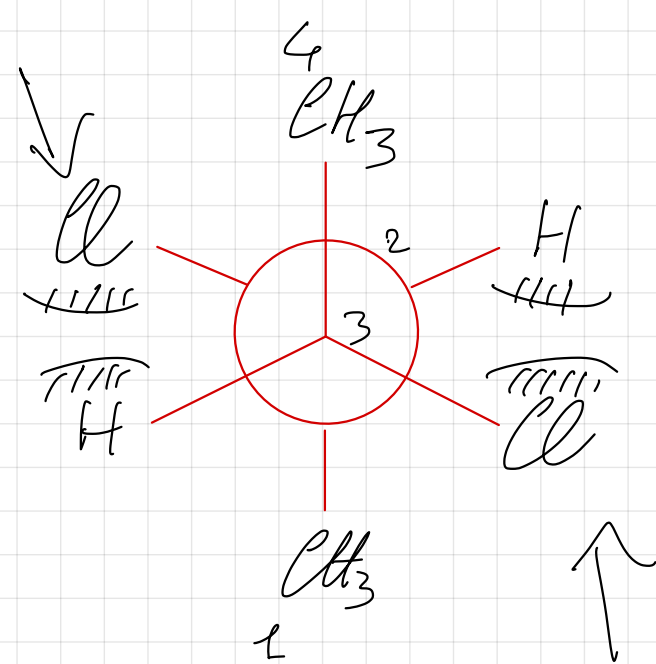
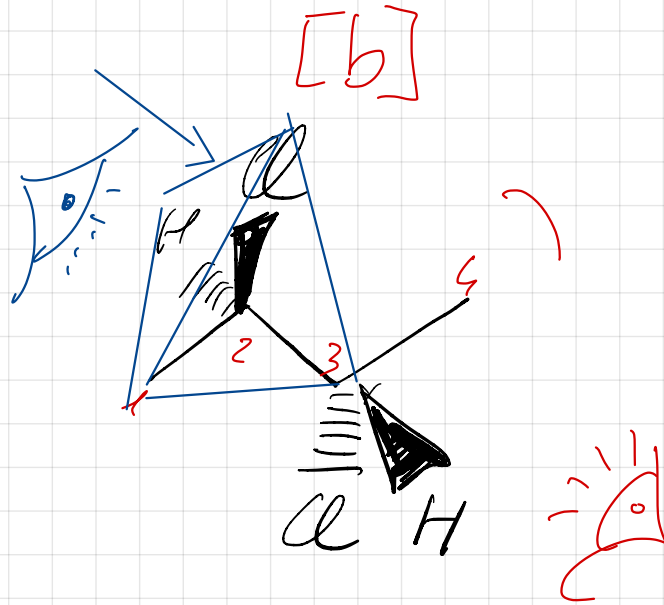
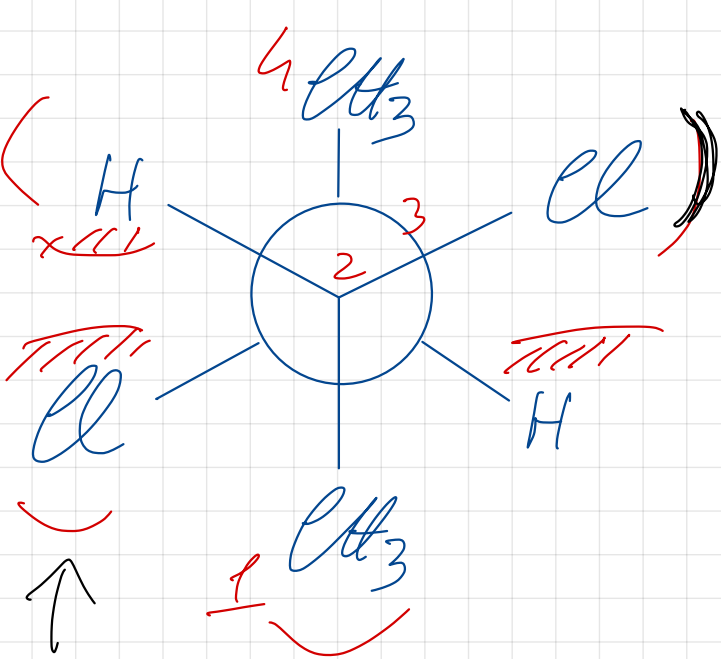

OSSERVATORE

C₂ - C₃

C₃ - C₂

B



OSSERVATORE

$C_3 - C_4$

3-metilossano

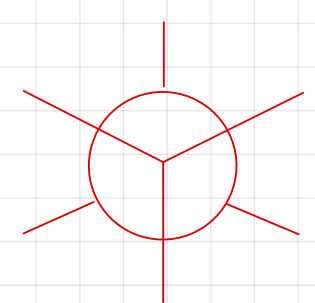
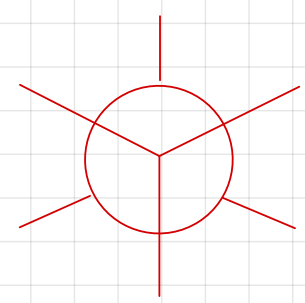
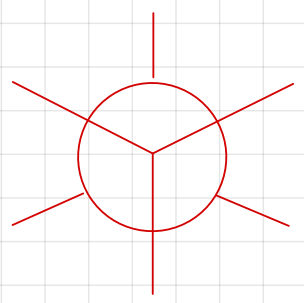
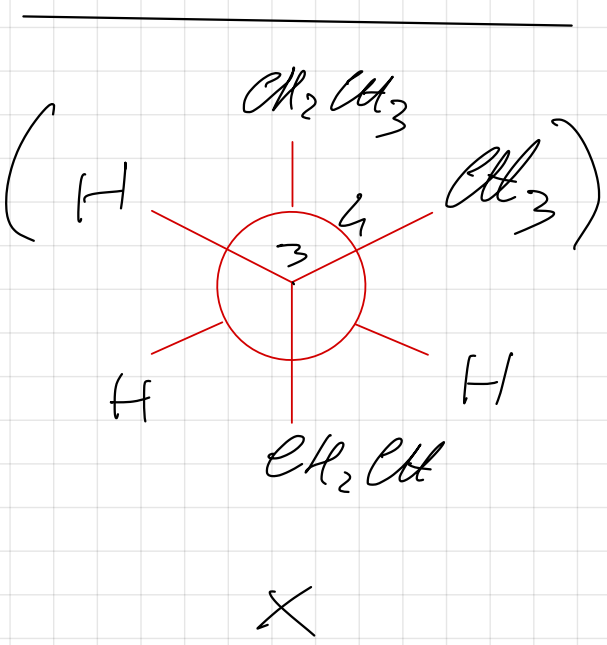
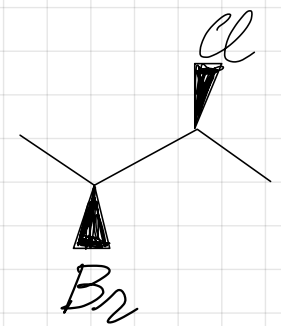
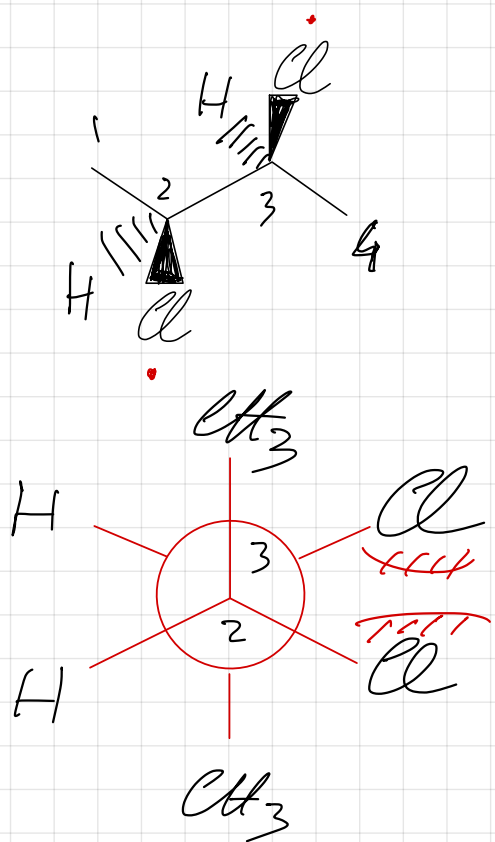
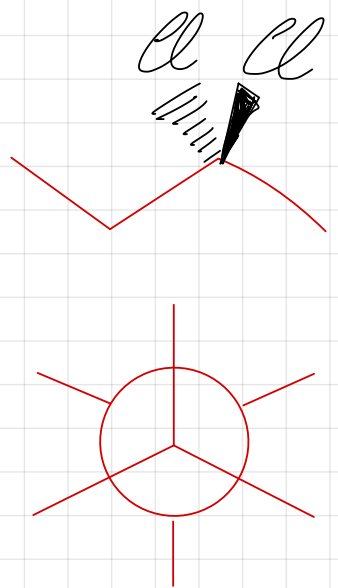
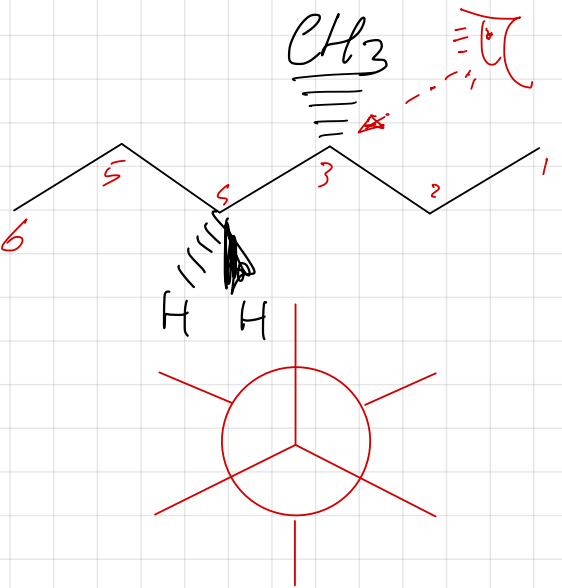

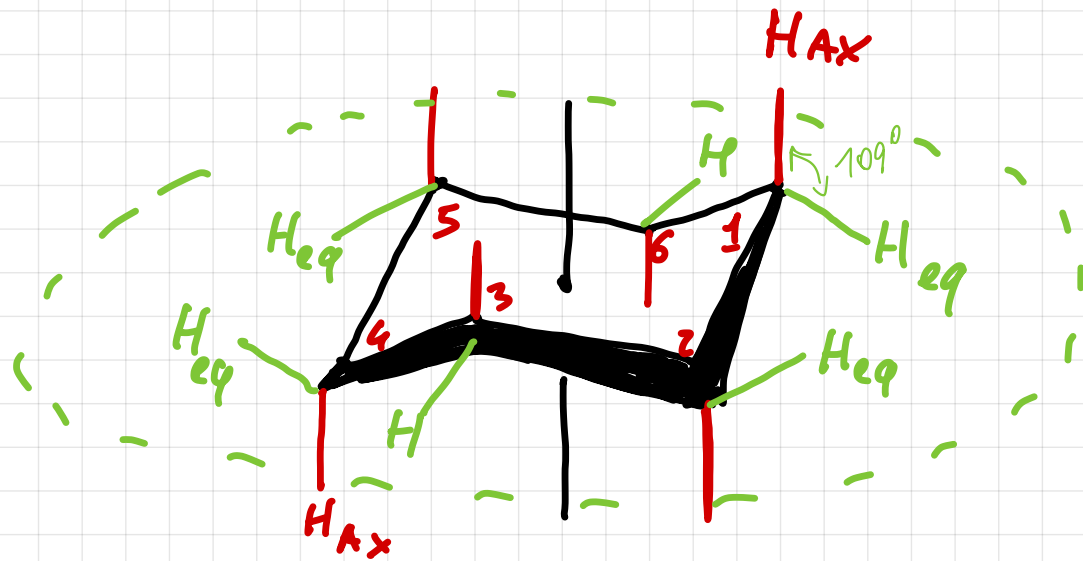
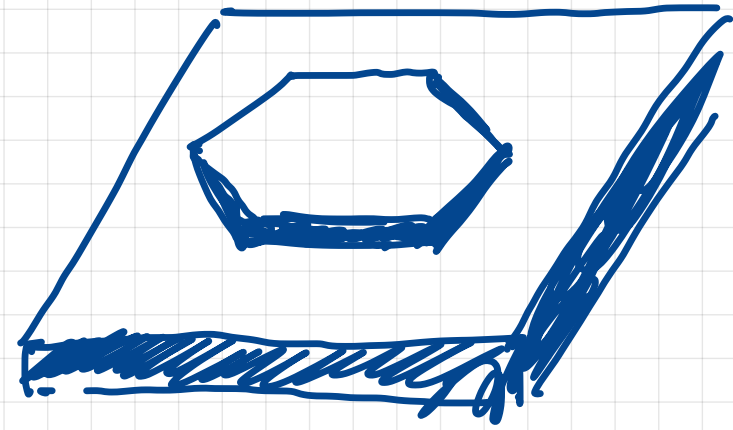
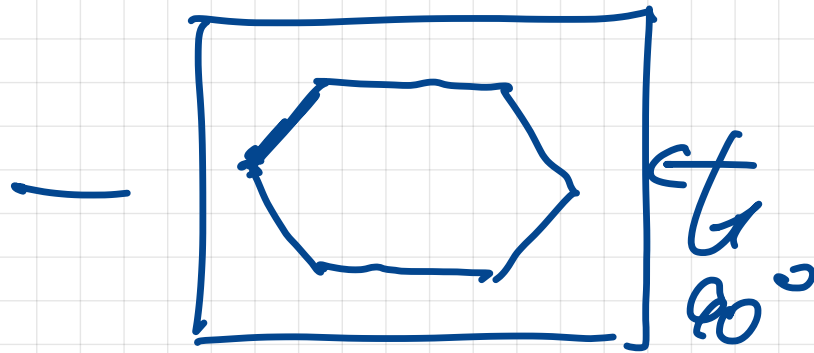
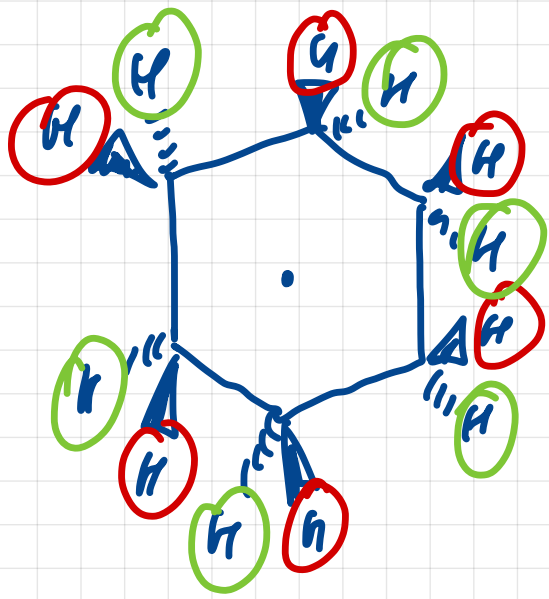

Linea
dell'equatore

6 H_{eq}

+ 6 H_{Ax}

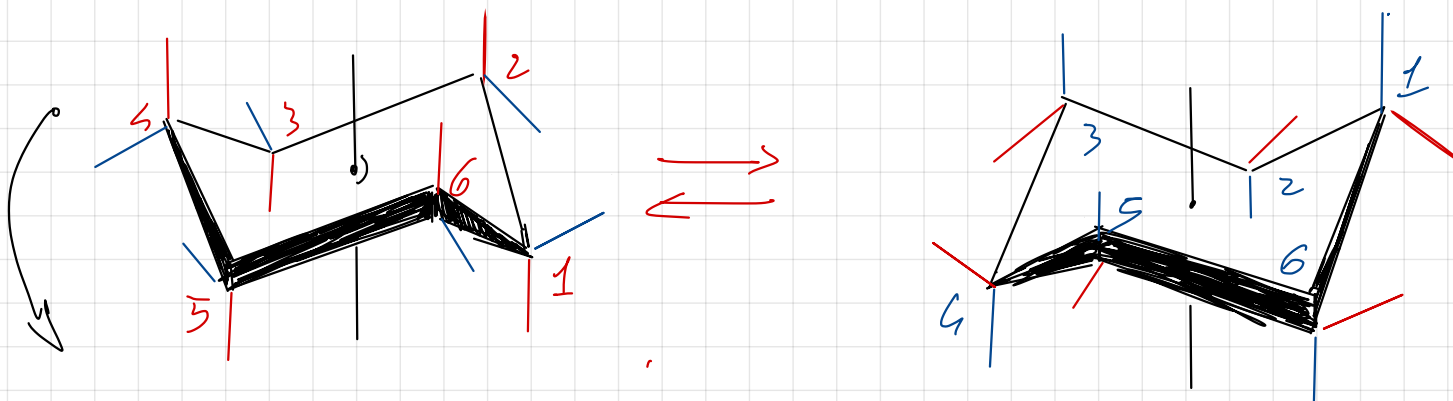
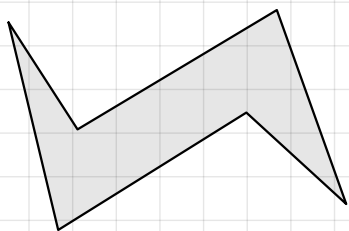
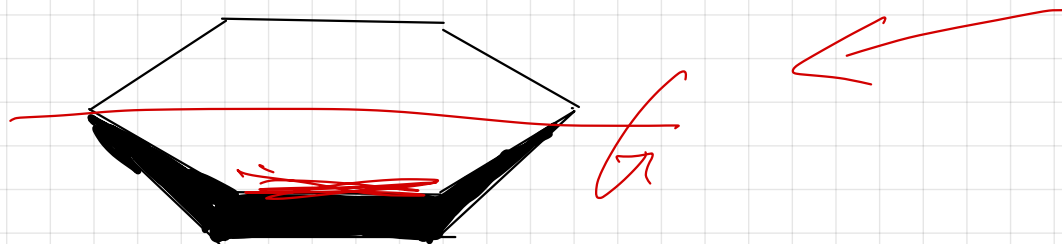
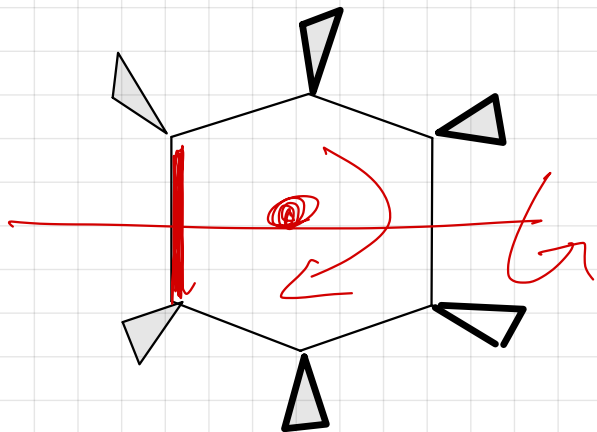

Inversione della sedia

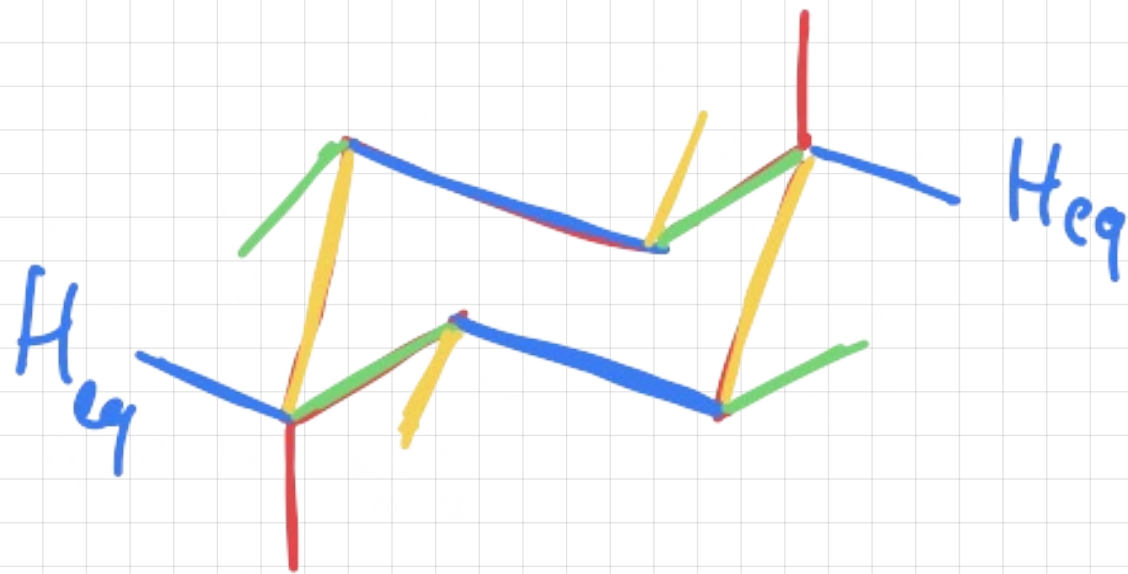

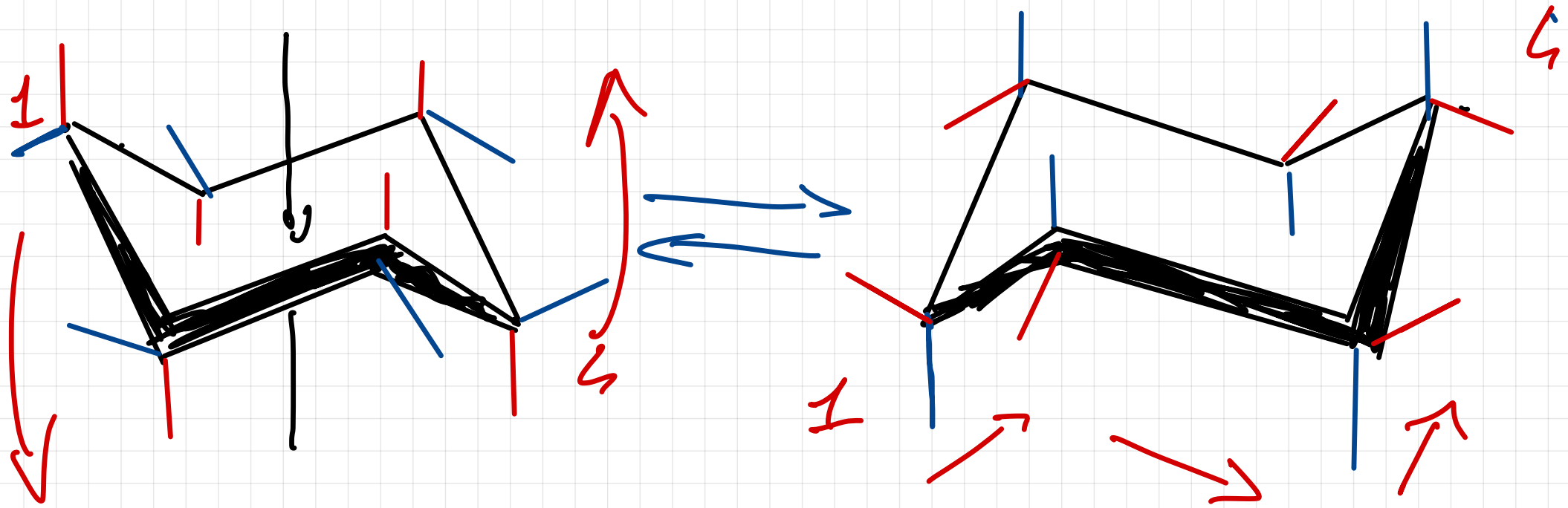

H_{eq}
 H_{as}

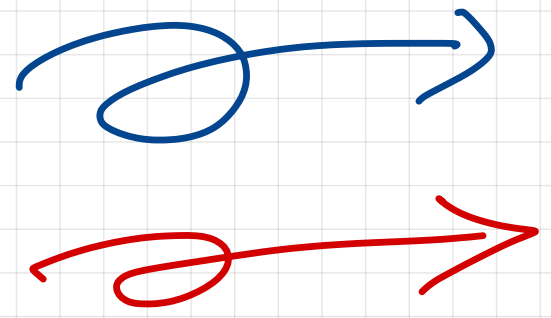

Classici
 Equatoriali

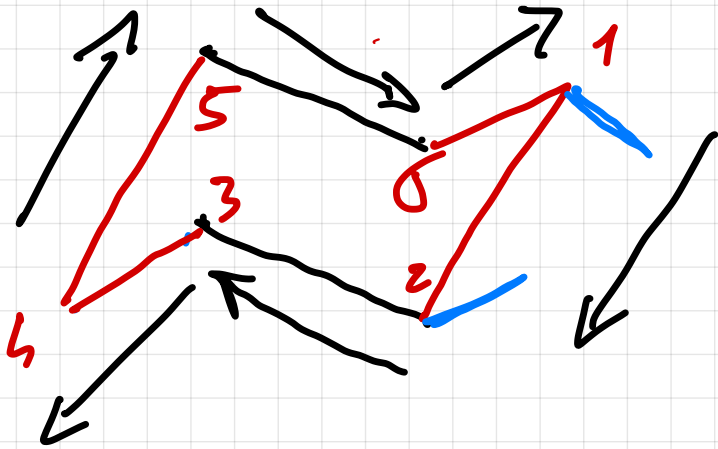

ERRORI COMUNI

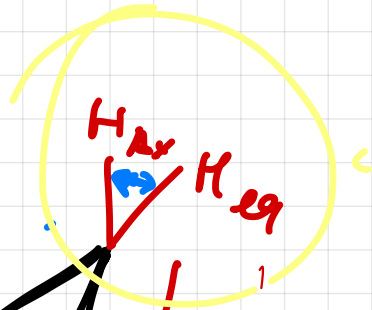
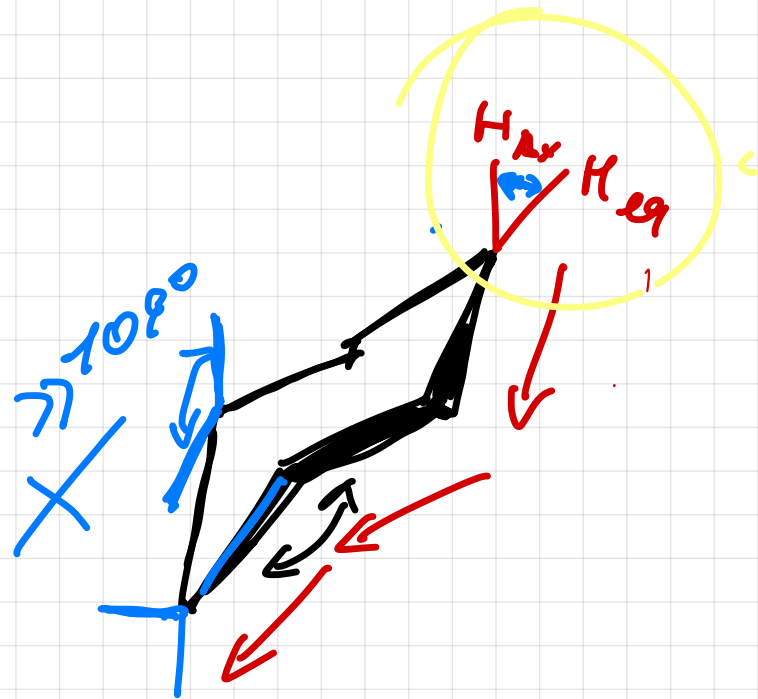
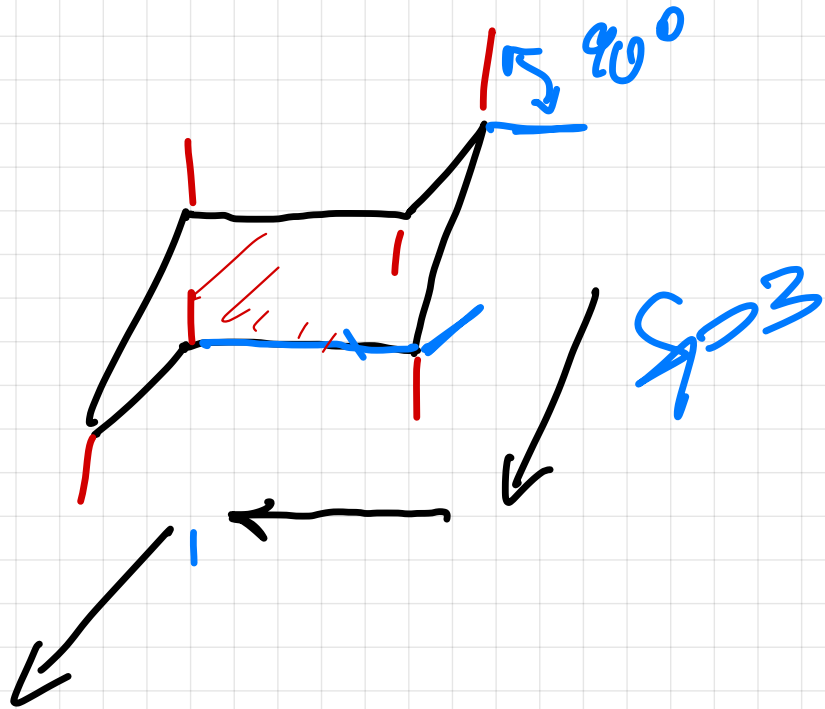

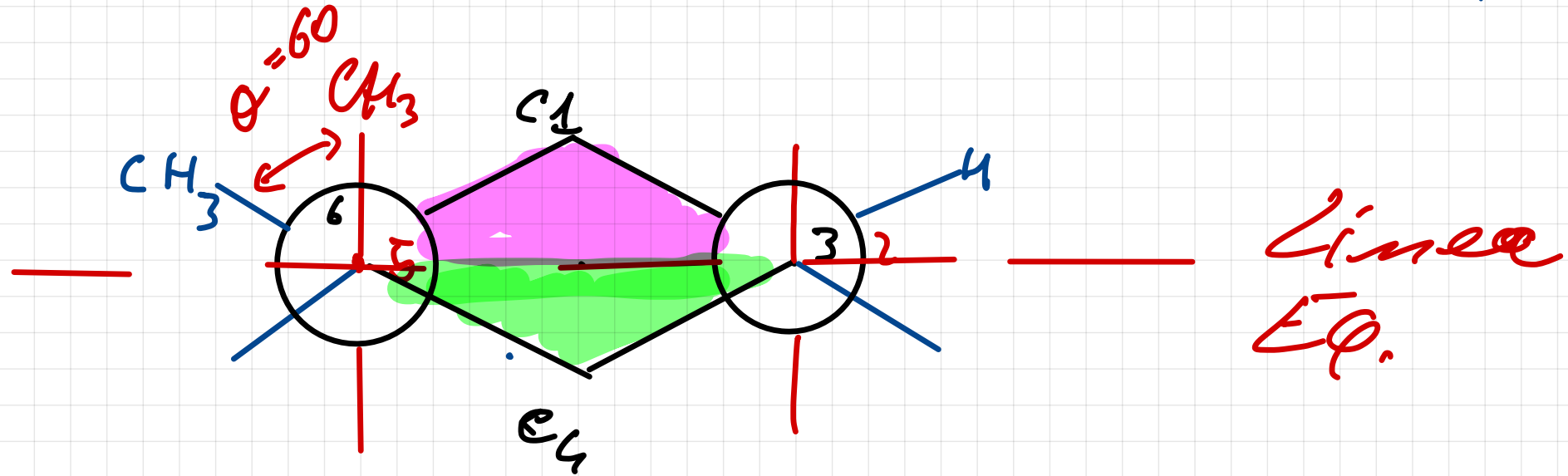
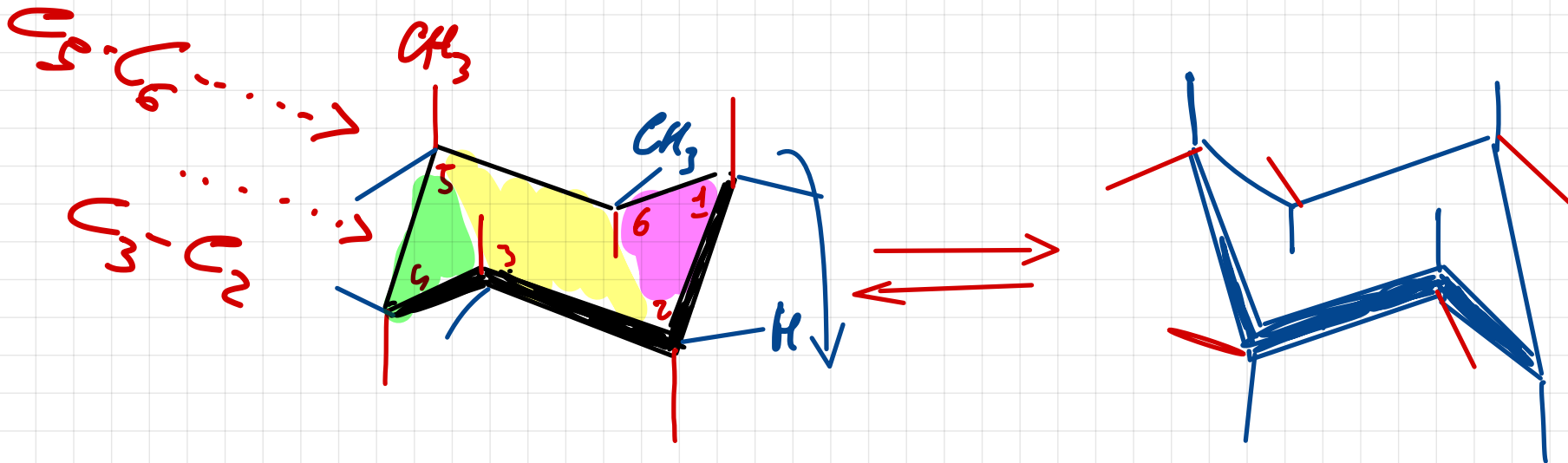

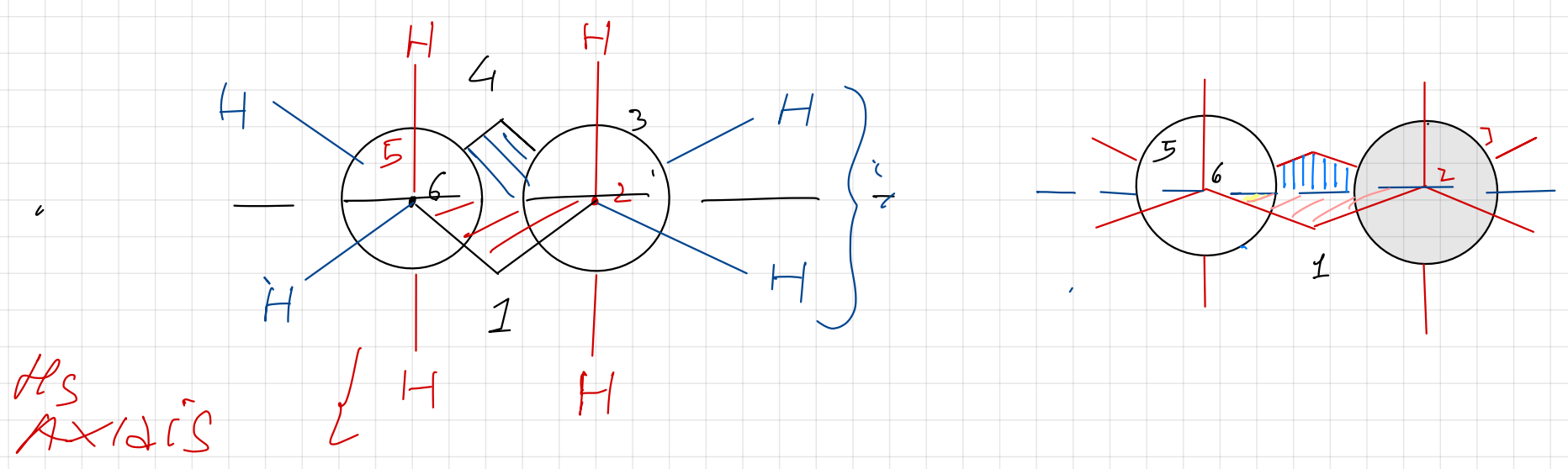
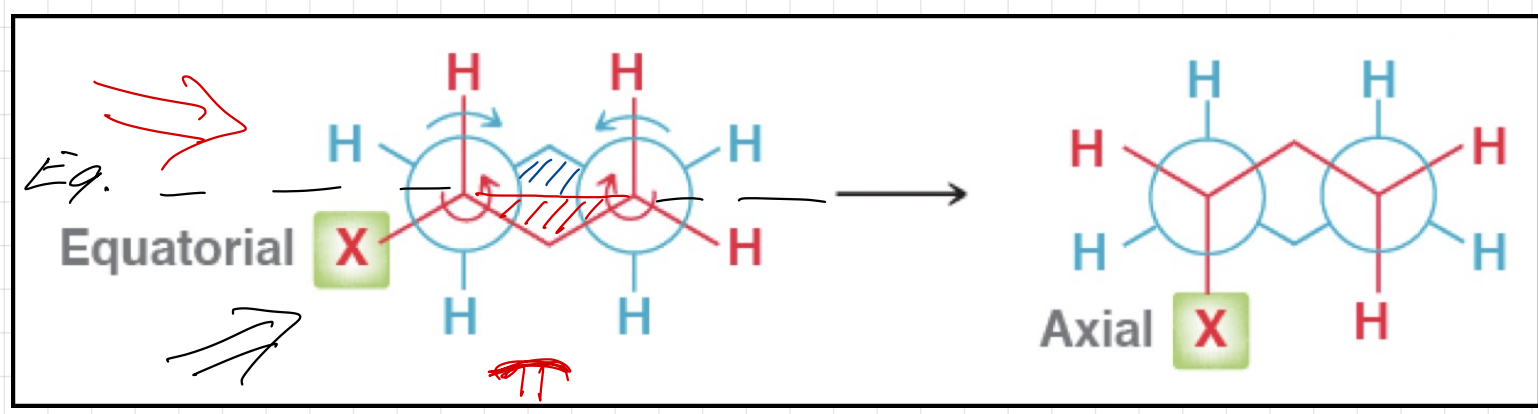
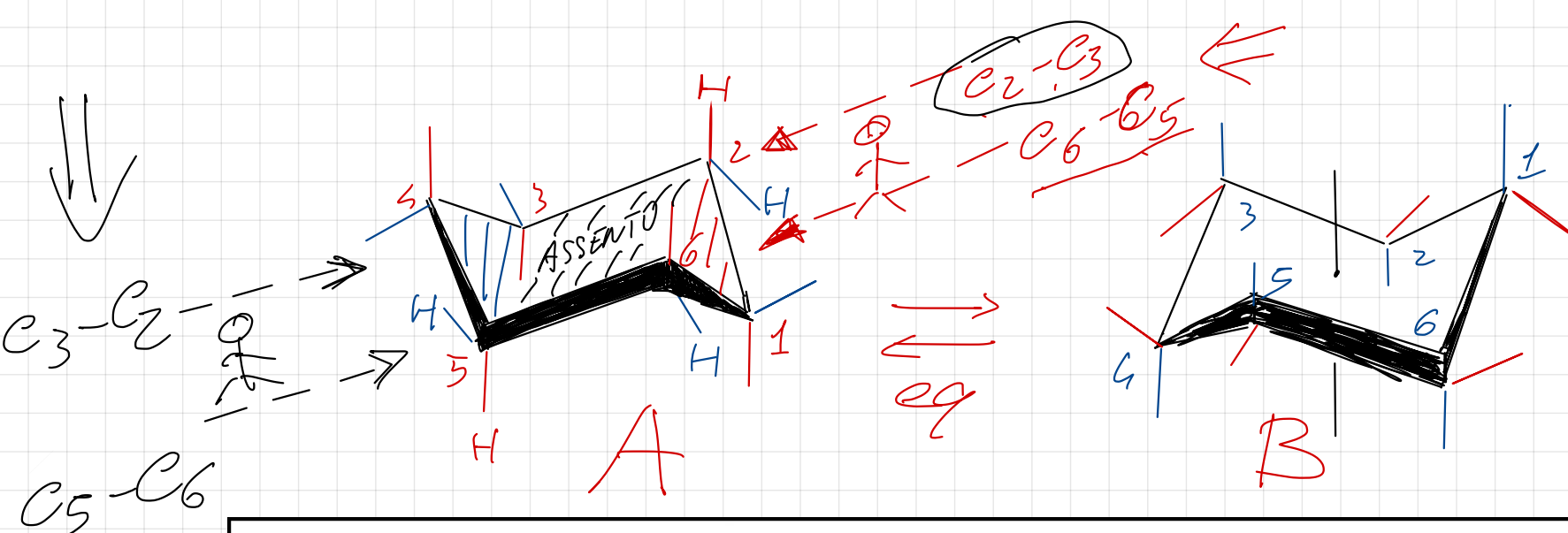

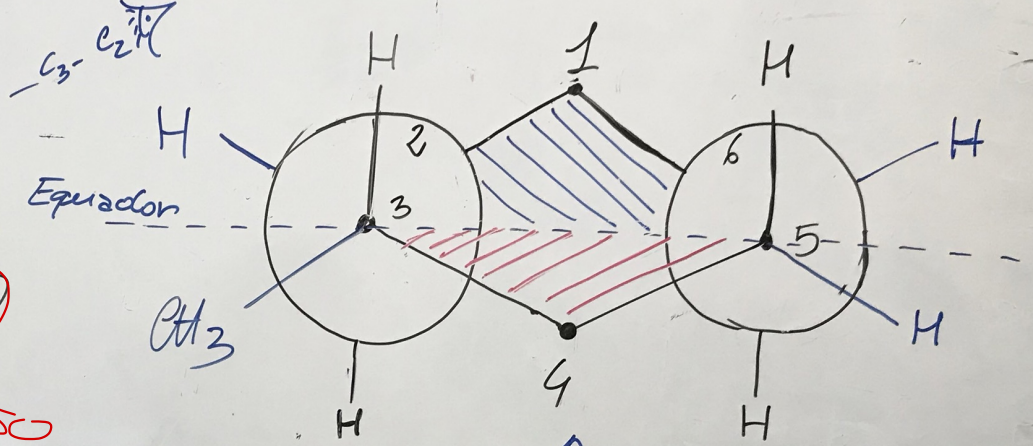
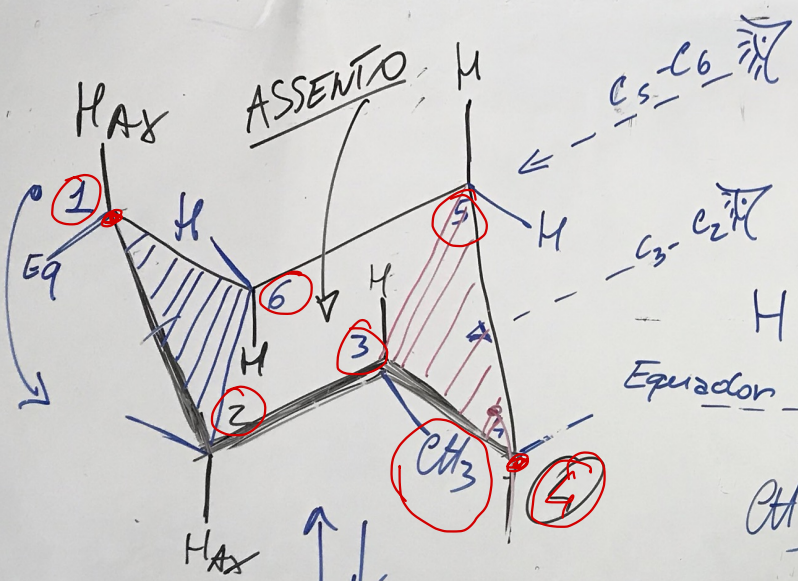

Inversão da cadeira

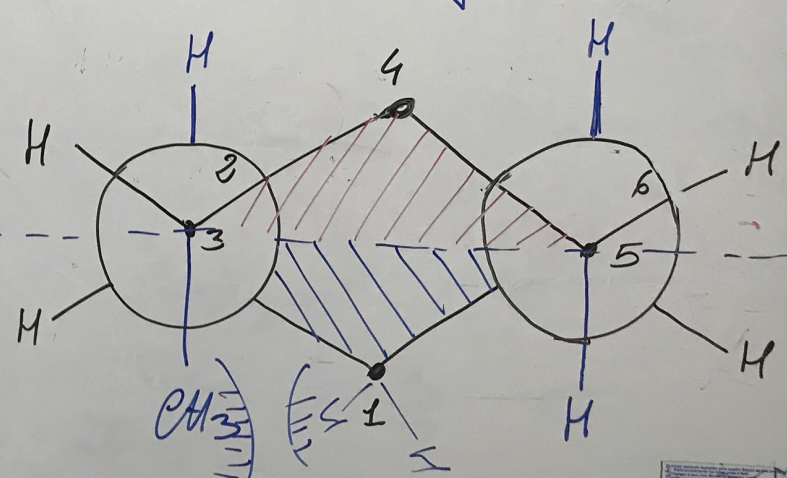
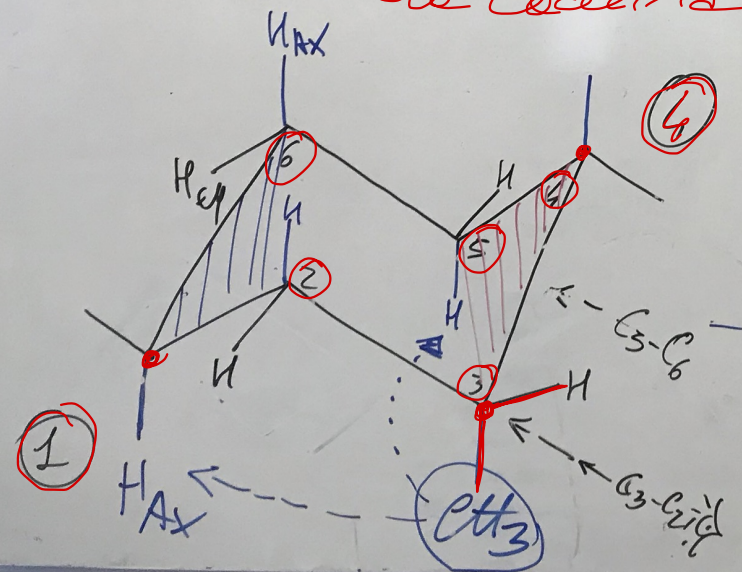

INTERAZIONI 1,3-dassiali

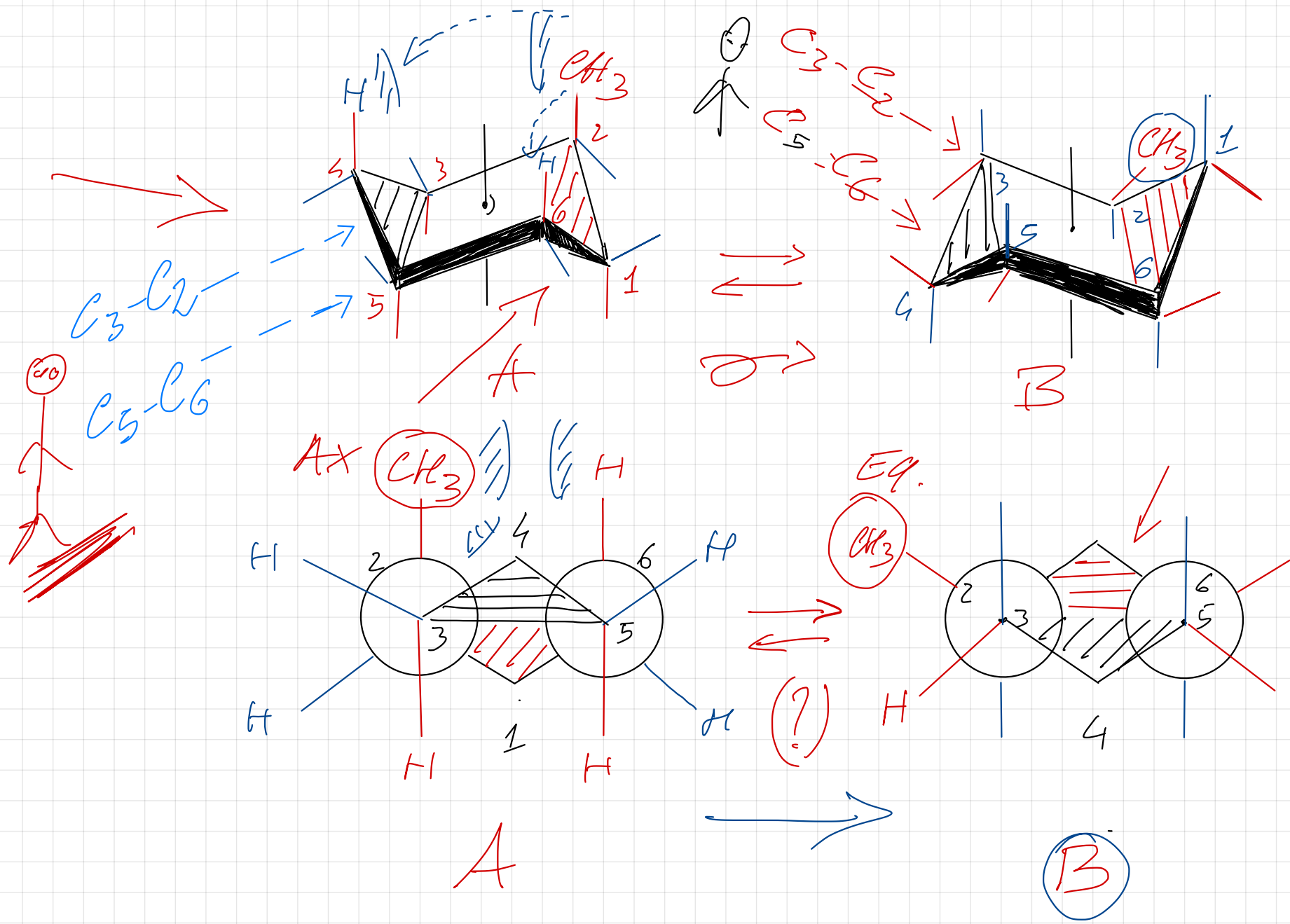

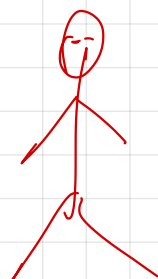

C_3-C_2
 C_5-C_6

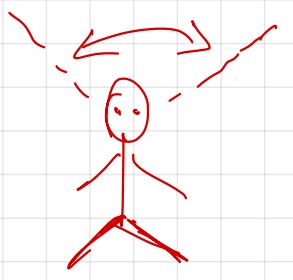
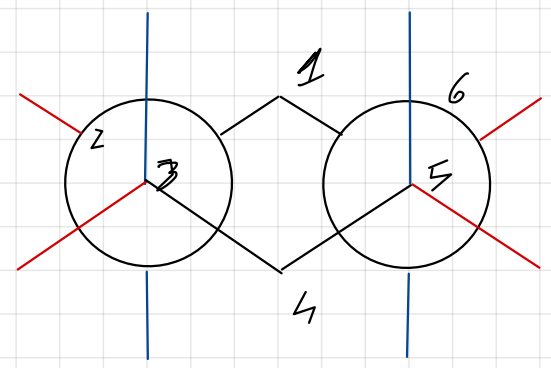
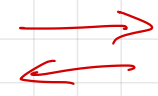
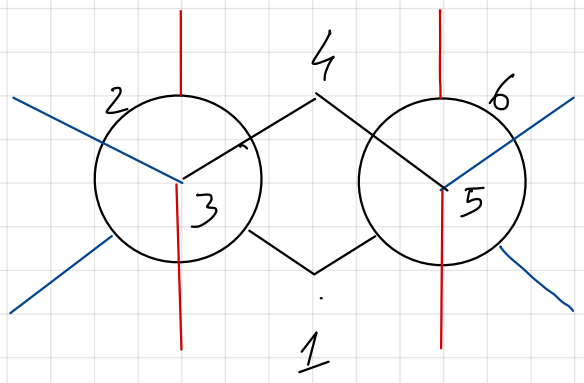
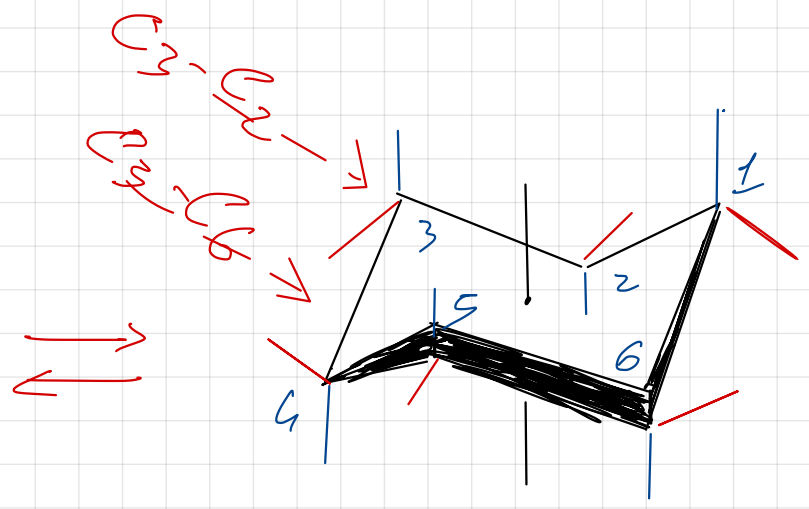
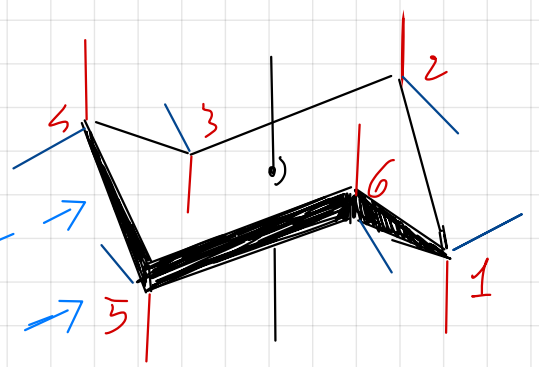

cis-1,2-dimetil cicloesano

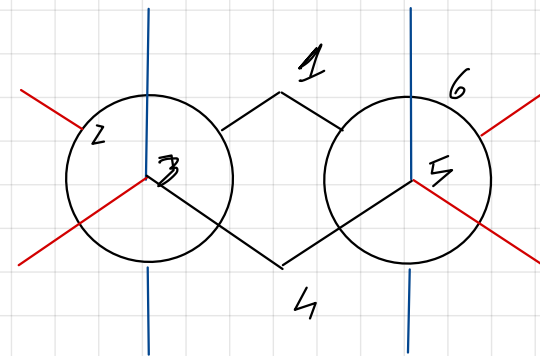
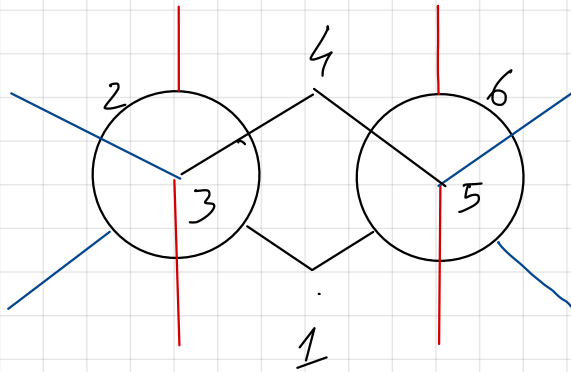
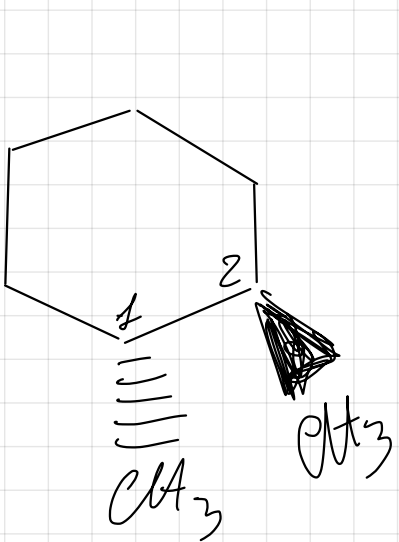
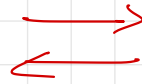
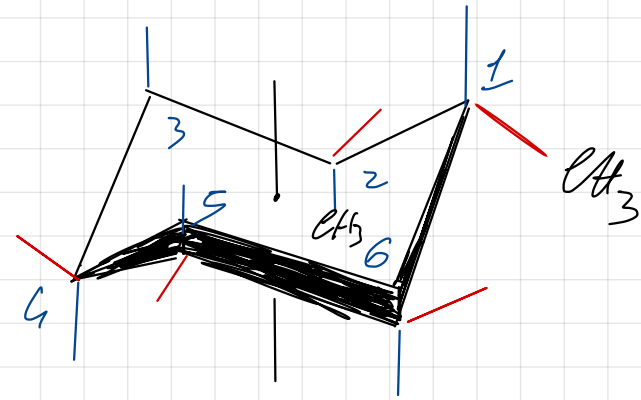
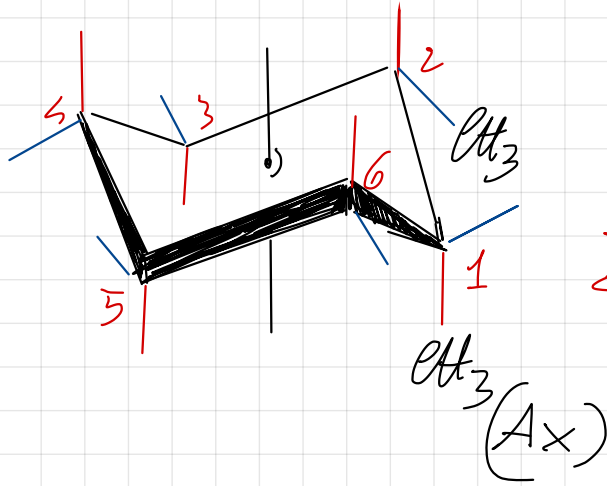
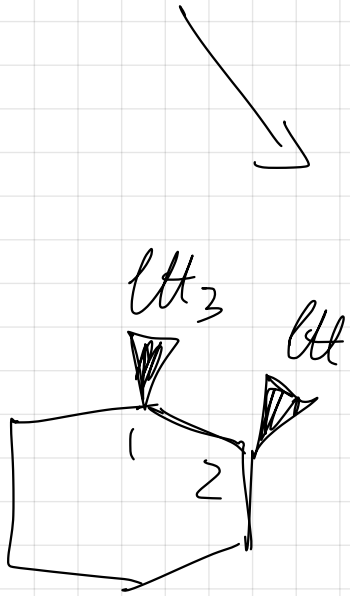



C_3-C_2
 C_5-C_6

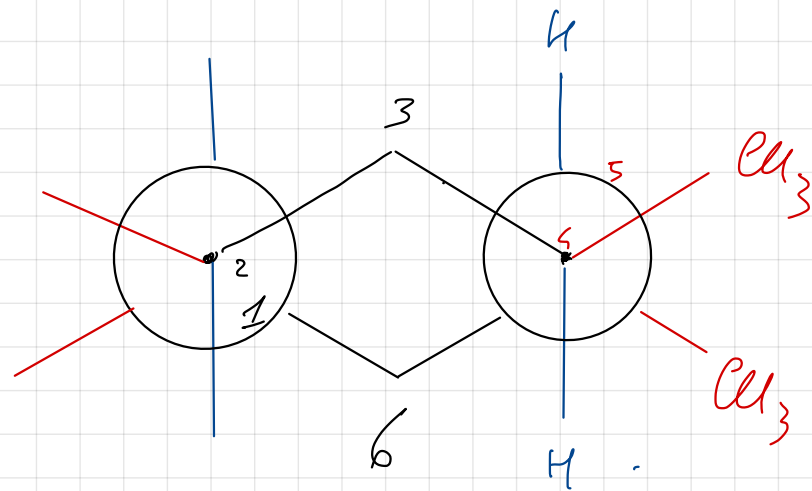
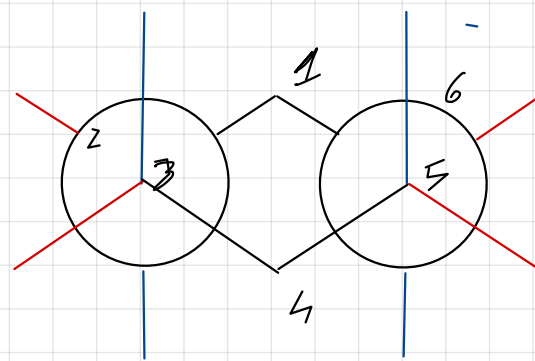
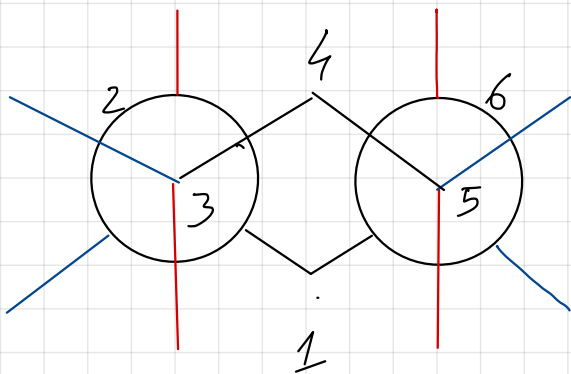
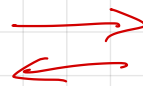
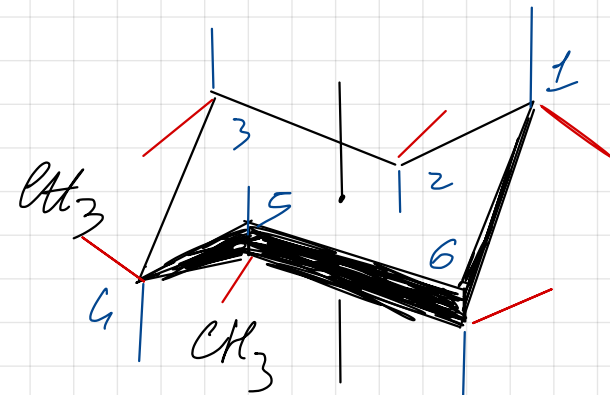
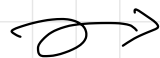
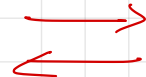
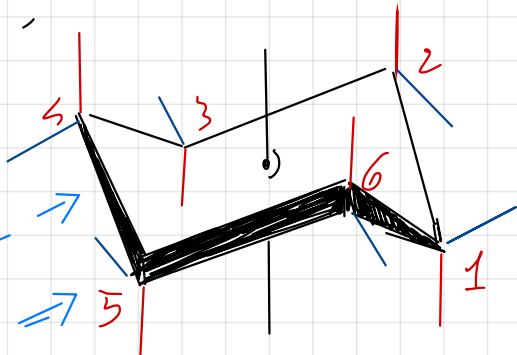

Individuare le conformazioni
a sedia del seguente ciclo esano
trisostituito.

